

MERLYN™
IONIC

Your shower your space™



Contents

Introduction

- 01 The MERLYN Ionic Collection

Product

- 07 **Essence Frameless**
Frameless elegance
- 17 **Essence Framed**
Precision engineered
- 25 **Wetroom Panels**
Flexibility for your space
- 27 **Express**
The ultimate easy fit solution
- 35 **Source**
Affordable shower enclosures
- 42 **SecureSeal**
The ultimate leak-free bath screen
- 44 **Bath Screens - Introducing our new Easy-Fit option**
Simple shapes
- 53 **Slip Resistant Trays**
- 54 **TouchStone Trays**
Strong and durable
- 58 **MERLYN Upstand Tray**

Technical Section

- 59 Product Information



The MERLYN Ionic Collection

Your Shower, Your Space

The MERLYN Ionic Collection features an extensive range of shower enclosures, trays and bath screens to suit every bathroom and every budget.

We spent many years researching our customers, installers and plumbers in the UK and Ireland. From this research we developed a range that is stylish, innovative, fast and easy to fit. The Ionic collection pairs precision engineering with the highest quality standards.

This range offers fantastic choice and functionality, you can be sure to find an enclosure to suit your bathroom space and budget. From the contemporary frameless Essence to the framed classic Express this collection has been developed to meet the highest quality standards while maintaining a very stylish look and feel. Create your beautiful bathroom today by selecting a MERLYN Ionic shower enclosure.



Essence Frameless | Page 07
The IONIC flagship range



Essence Framed | Page 17
A range offering multi function and choice



Wetroom Panels | Page 25
Mix and match combination of shapes and sizes



Express | Page 27 | Low Level Sliding Door
The easiest fit system on the market



Source | Page 35
Excellence in design, durability and affordability



SecureSeal | Page 42
Leak free solution for baths



Bath Screens | Page 44
Contemporary screens that work with baths



TouchStone Trays | Page 53
Elegant low level installation trays



Upstand Trays | Page 55
Great value low level installation trays with upstand

Choose your Style

Products

	Shape	Essence Frameless	Essence Framed
Sliding Door	Rectangular	✓	✓
Quadrant Door	Curved	✓	✓
Hinged Door	Rectangular	✓	–
Pivot Door	Square	–	✓
Bifold Door	Square	–	✓
Wetroom / Walk-In	Rectangular	–	–
Corner Entry	Square	–	–
Inline Panel	–	–	–
Bath Screen	–	–	–
Easy Fit System	–	–	–
Glass Thickness	–	8mm	8mm
Height	–	2000mm	1900mm
Guarantee	–	20 Years	20 Years



UKCA & EN Information **UK CA** **CE**

The UKCA (UK Conformity Assessment) mark on MERLYN enclosures is the new standard marking for products on the market in Great Britain (England, Wales and Scotland). It is a declaration that the product complies with GB designated standards. Further information on the UKCA, CE and EN (toughened safety glass standard EN 12150) marks is available on our website: www.merlynshowering.com.

For further information see Technical Section on page 59.

Wetroom Panels	Express	Source	SecureSeal	Bath Screens	Trays
-	✓	✓	-	-	✓
-	✓	✓	-	-	✓
-	-	-	-	-	✓
-	✓	✓	-	-	✓
-	✓	✓	-	-	✓
✓	-	-	-	-	✓
-	-	-	-	-	✓
-	✓	-	-	-	-
-	-	-	✓	✓	-
-	✓	✓	-	-	-
8mm	6mm	6mm	6mm	4, 6 & 8mm	-
2000mm	1900mm	1850mm	1500mm	1400-1500mm	-
20 Years	20 Years	5 Years	Lifetime	Lifetime	10 Years

ISO Certification

MERLYN has implemented an Integrated Management System comprising of Quality Management, Environmental Management and Occupational Health and Safety Management. An Integrated Management System ensures the seamless integration of several different standards into a common system that meets the requirements of each of these standards. These certifications are proof of **MERLYN**'s credibility but also to instil confidence in our potential clients that **MERLYN** will keep its promises.





MerShield Stayclear™

MERLYN™ treats products in the Ionic Collection with a special protective coating to ensure the glass maintains its sparkle. This comes as standard on Essence, Express, Wetroom Panels and most of our Bath Screen range.

MerShield Stayclear™ acts as a protective coating which when applied to glass, helps the glass to remain shiny and new without the need for tiresome cleaning. When cleaned correctly it helps prevent the build up of limescale and soap deposits making the shower glass “easy to clean”. Please see tips for keeping the glass in pristine condition.

Without MerShield Stayclear™ Protective Coating

Without MerShield Stayclear™ protection water and soap deposits cling to the glass surface causing a build up of grime, requiring more vigorous cleaning.

Natural glass surface

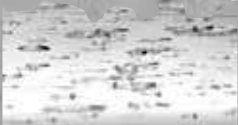

With MerShield Stayclear™ Protective Coating

The MerShield Stayclear™ coating provides a larger contact angle for the water droplet on the surface and makes the drops smaller than drops falling on an untreated surface. This ensures the droplets roll away much faster down the surface, minimising deposits left behind.

MerShield Stayclear™ coating

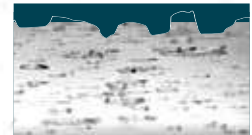

MerShield Stayclear™ coating creates a smooth layer over the surface of natural glass, lowering surface friction, making it easier for water, soap and lime deposits to run off the glass.

Tips on how to keep your glass in pristine condition

It is important to clean your glass after every use – wipe down with a soft cloth.

Install the enclosure in a well ventilated area.

Do not allow limescale to build up in hard water areas.

Ensure that any residual water on the glass is removed after every use.

Clean the glass regularly using soapy water.

DO NOT use abrasive products on any surfaces.

*Check out
our website at
www.merlynshowering.com*

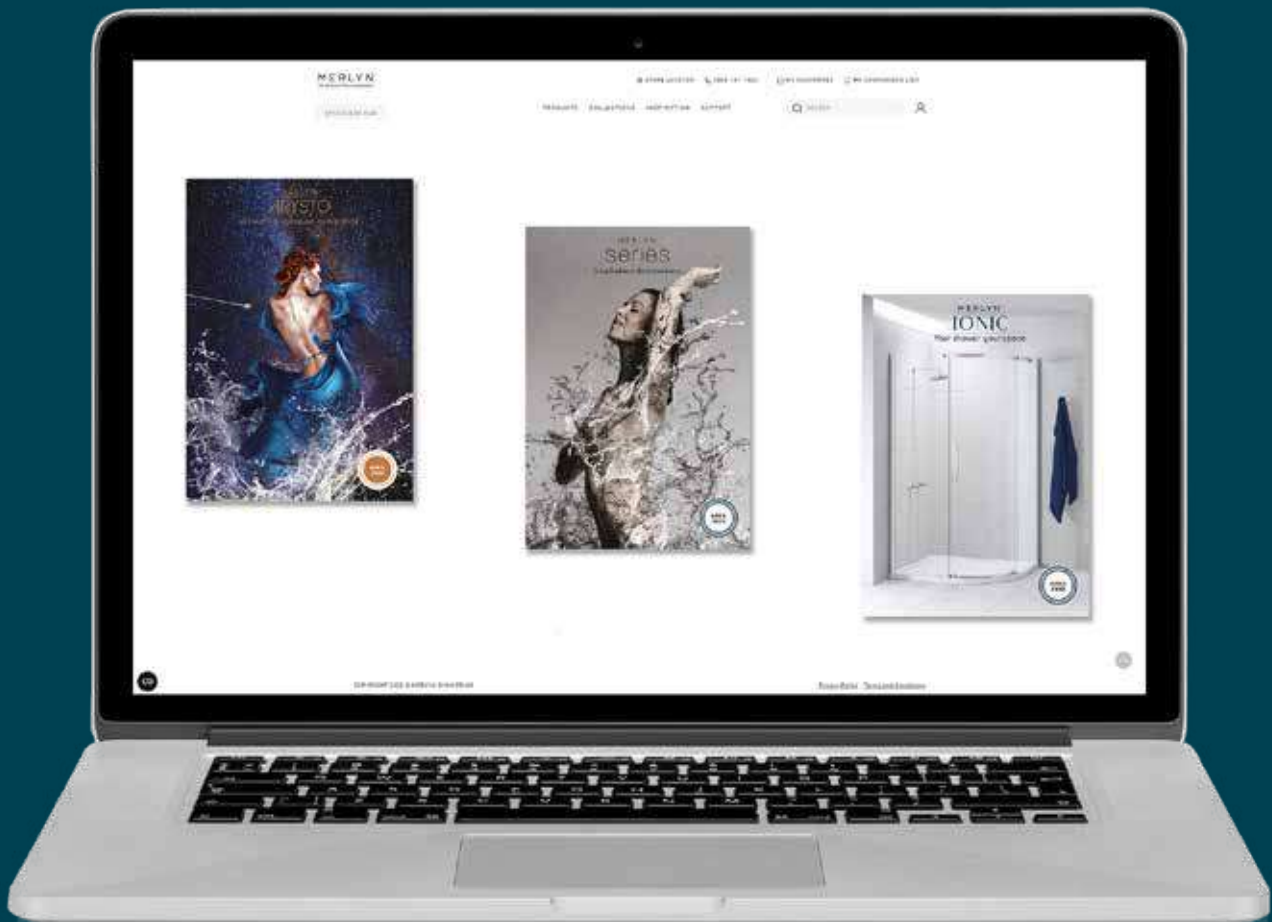

Download our brochures.

Find your nearest stockist.

Download our easy-to-use fitting instructions
and technical information.

Register your Guarantee.

Keep up to date with our latest news.

Follow us online @merlynshowering to keep up to-date. [f](#) [@](#) [t](#) [in](#) [▶](#) [p](#)

Essence Frameless



Frameless Elegance

Ionic Essence is truly unique in its appearance with its fusion between stylish beauty and precision engineering. We have spent a great deal of time developing this range that not only exudes style; it also stays true to the basic Ionic principle: built to last.

Some additional features include concealed rollers to ensure it looks just as good on the inside as it does on the outside, discreet seals to help retain its frameless look, extra strong rollers that have gone through rigorous testing procedures along with many other little details that have been incorporated to ensure this product fits as seamlessly as possible for the installer.

Design Details



1 Branded glass clamp



4 Designer hinge with concealed pivot



2 Solid chrome double handle



3 Branded badge



5 Chrome double handle

Features

- Height 2000mm
- Stunning frameless design
- Reversible*
- Concealed fixings
- Exclusive Essence fixings kit provided
- Chrome double handle

*Quadrant Doors are handed.



Sliding Door in a Recess



Sliding Door with a Side Panel



Hinge & Inline Panel in a Recess

Frameless Elegance

The attention to detail is evident throughout this range with many additional clever features that ensure it is practical and functional while also maintaining its frameless elegance.



Hinge & Inline Panel with a Side Panel



1 Door Offset Quadrant



1 Door Quadrant



Features

Sliding Door shown as Right Hand



 2000mm

 Smooth action
extra strong rollers

 Minimalist designer rail
with concealed rollers both
inside and outside

 Concealed fixing

 Stunning frameless
design

 Chrome double handle

 Reversible

 Discreet deflection seal
on luna rail for increased
water retention

Essence Frameless

Sliding Door



Product Details

Extension profiles available see page 62

Size	Adjustment in Recess (Min-Max)	Adjustment with Side Panel (Min-Max)	Code	Price £ Exc. VAT	Price £ Inc. VAT
1000	950-990	940-965	A0104A0	1154.28	1385.14
1100	1050-1090	1040-1065	A0104B0	1154.28	1385.14
1200	1150-1190	1140-1165	A0104IH	1154.28	1385.14
1400	1350-1390	1340-1365	A0104DH	1224.33	1469.19
1700	1650-1690	1640-1665	A0104HH	1399.48	1679.37

Optional Side Panel

800	760-785	A0107I0	628.79	754.55
900	860-885	A0107J0	663.87	796.64

Technical Details

Sliding Door in Recess

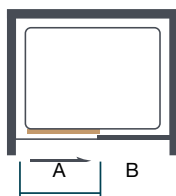

Size	A	B
1000	365	465
1100	415	515
1200	465	565
1400	565	665
1700	565	965

Sliding Door with Side Panel

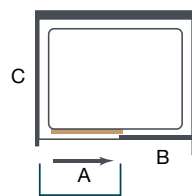

Size	A	B
1000	350	465
1100	400	515
1200	450	565
1400	550	665
1700	550	965

A = Door Opening
B = Fixed Panel
C = Side Panel









Features

Hinge and Inline in Recess shown as Right Hand

 20 YEARS GUARANTEE

 MERSHIELD STAYCLEAR

 8^{MM} GLASS THICKNESS

-  2000mm
-  Concealed fixing
-  Reversible
-  Solid chrome double handle symmetrical to hinges
-  Solid designer hinge with concealed pivot point
-  Stunning frameless design

Hinge & Inline Panel in a Recess



Hinge and Inline in Recess shown as Right Hand

Product Details

Extension profiles available see page 62

Technical Details

- A = Door Opening
- B = Door Swing
- C = Inline Panel

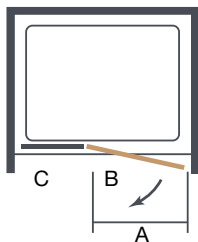

Please Note: Side Panel should only be used with + sizes (not standard sizes).

Size	A	B	C
760	440	460	160
800	440	460	200
800+	480	500	200
900	490	510	250
900+	530	550	250
1000	540	560	300
1000+	580	600	300
1100	590	610	350
1100+	630	650	350
1200	590	610	450
1200+	630	650	450
1400	590	610	650
1400+	630	650	650
1500	590	610	750
1500+	630	650	750

Size	Adjustment (Min-Max)	Code	Price £ Exc. VAT	Price £ Inc. VAT
760	720-760	A0111F0	994.90	1193.88
800	760-800	A0111C0	994.90	1193.88
800+	800-840	A0111M0	994.90	1193.88
900	860-900	A0111D0	994.90	1193.88
900+	900-940	A0111N0	994.90	1193.88
1000	960-1000	A0111E0	1047.45	1256.95
1000+	1000-1040	A0111O0	1047.45	1256.95
1100	1060-1100	A0111JH	1108.76	1330.52
1100+	1100-1140	A0111JF	1108.76	1330.52
1200	1160-1200	A0111GH	1108.76	1330.52
1200+	1200-1240	A0111GF	1108.76	1330.52
1400	1360-1400	A0111HH	1189.35	1427.22
1400+	1400-1440	A0111HF	1189.35	1427.22
1500	1460-1500	A0111KH	1276.87	1532.24
1500+	1500-1540	A0111KF	1276.87	1532.24



Hinge and Inline with Side Panel shown as Right Hand

Features



20 YEARS
GUARANTEE



MERSHIELD
STAYCLEAR



8^{MM}
GLASS
THICKNESS



2000mm



Concealed fixing



Reversible



Solid chrome double handle
symmetrical to hinges



Solid designer hinge
with concealed pivot point



Stunning frameless
design

Hinge & Inline Panel with Side Panel

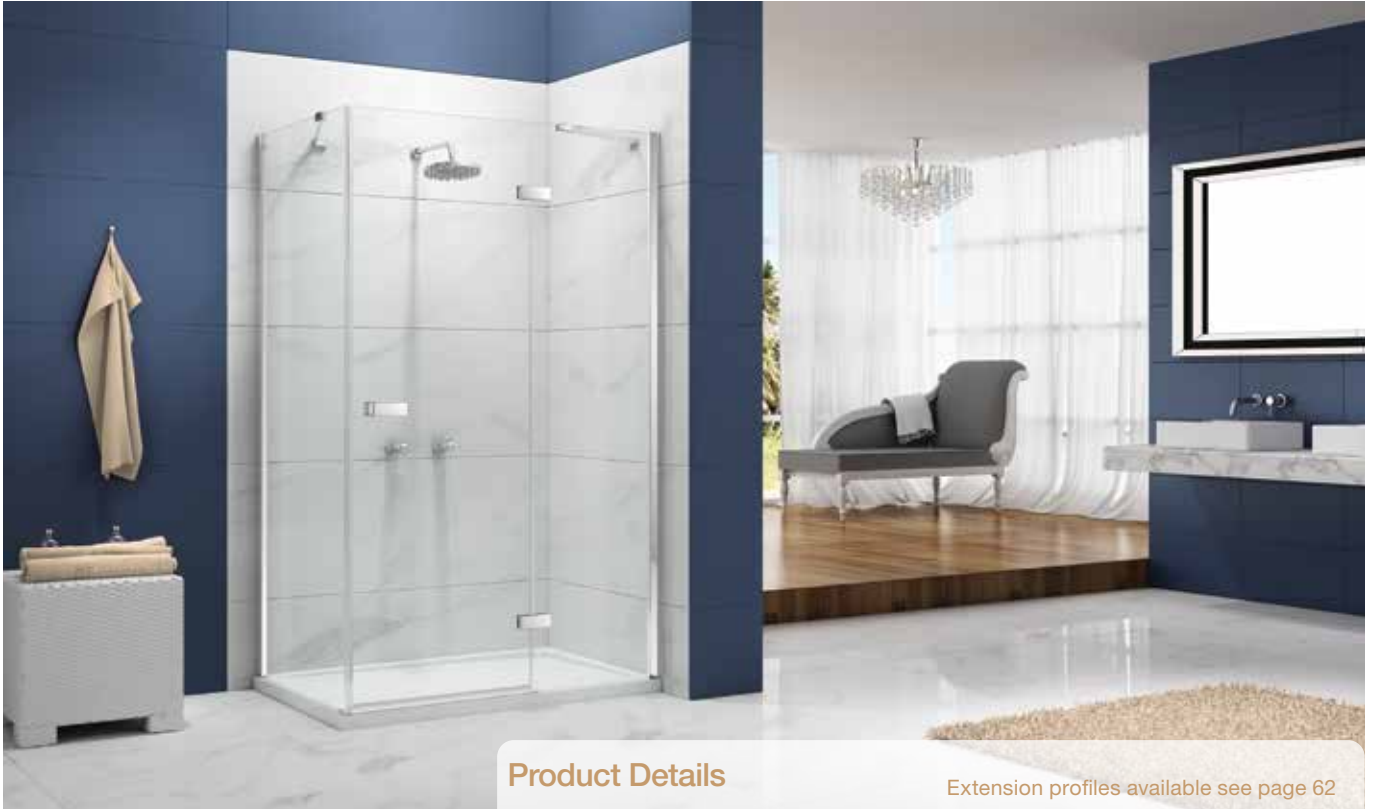

Product Details

Extension profiles available see page 62

Technical Details

- A = Door Opening
- B = Door Swing
- C = Inline Panel
- D = Side Panel

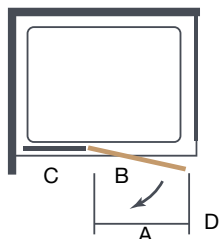

Please Note: Side Panel should only be used with + sizes (not standard sizes).

Size	Adjustment (Min-Max)	Code	Price £ Exc. VAT	Price £ Inc. VAT
800+	770-790	A0111M0	994.90	1193.88
900+	870-890	A0111N0	994.90	1193.88
1000+	970-990	A0111O0	1047.45	1256.95
1100+	1070-1090	A0111JF	1108.76	1330.52
1200+	1170-1190	A0111GF	1108.76	1330.52
1400+	1370-1390	A0111HF	1189.35	1427.22
1500+	1470-1490	A0111KF	1276.87	1532.24

Optional Side Panel				
800	750-790	A0107G0	576.22	691.47
900	850-890	A0107H0	611.33	733.59

Size	A	B	C
800+	480	500	200
900+	530	550	250
1000+	580	600	300
1100+	630	650	350
1200+	630	650	450
1400+	630	650	650
1500+	630	650	750



Features

1 Door Offset Quadrant shown as Left Hand



20 YEARS
GUARANTEE



MERSHIELD
STAYCLEAR



8^{MM}
GLASS
THICKNESS



2000mm



Concealed fixing



Smooth action
extra strong rollers



Chrome double handle



Stunning frameless
design



Minimalist designer rail
with concealed rollers
both inside and out



Discreet deflector seal on luna rail
for increased water retention



Extra strong rollers with additional
guide to added smoothness.

1 Door Quadrants



1 Door Quadrant

Product Details

Extension profiles available see page 62

Size	Adjustment (Min-Max)	Handed	Code	Price £ Exc. VAT	Price £ Inc. VAT
900 x 900	860-885	Left Hand	A0101MH	1574.64	1889.56
900 x 900	860-885	Right Hand	A0101NH	1574.64	1889.56
1200 x 900	860-885 / 1160-1185	Left Hand	A0101KH	1749.81	2099.77
1200 x 900	860-885 / 1160-1185	Right Hand	A0101LH	1749.81	2099.77

Technical Details

1 Door Quadrant

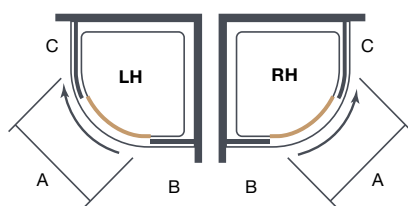

Size	A	B	C
900	475	290	550

1 Door Offset Quadrant

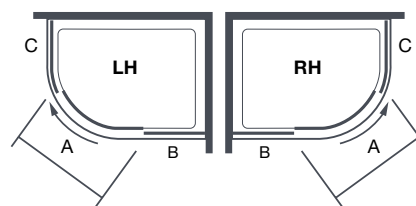

Size	A	B	C
1200 x 900	475	590	550

A = Door Opening
B = Straight Panel
C = Curved Panel

Essence Framed



Precision Engineered

Ionic Essence Framed is a stylish 8mm range, precision engineered to suit every bathroom space. Some of the main features of this range include the solid “Clunk” which highlights the quality of these enclosures. Colour matched chrome magnetic seals and concealed fittings to ensure it looks great all around and quick release double rollers which makes it hassle-free to clean.

Features

-  Height 1900mm
-  Concealed fixings
-  Solid ‘Clunk’ close
-  Reversible
-  Colour matched chrome magnetic seals

Design Details





Sliding Door with Side Panel



Sliding Door in a Recess



2 Door Quadrant

Precision Engineered

The framed beauty of this range delivers on functionality while maintaining the Ionic principle: built to last.



1 Door Quadrants



Pivot Door with Side Panel



Bifold Door in a Recess



Features



Sliding Door with Side Panel

 20 YEARS GUARANTEE

 MERSHIELD STAYCLEAR

 8^{MM} GLASS THICKNESS

-  1900mm
-  Concealed fixing
-  Reversible

-  Easy clean quick release rollers
-  Chrome finish including top cover caps
-  Chrome magnetic strips

-  Smooth action extra strong rollers

Sliding Door



Sliding Door in a Recess

Product Details

Extension profiles available see page 62

Size	Adjustment (Min-Max)	Code	Price £ Exc. VAT	Price £ Inc. VAT
1000	930-990	DWH04A0	795.51	954.62
1100	1030-1090	DWH04B1	795.51	954.62
1200	1130-1190	DWH04C0	795.51	954.62
1400	1330-1390	DWH04DH	919.19	1103.03
1700	1630-1690	DWH04EH	1061.25	1273.50

Optional Side Panel

760	720-750	DWH07B0	370.56	444.67
800	760-790	DWH07D0	370.56	444.67
900	860-890	DWH07E0	436.91	524.29

Technical Details

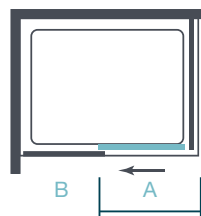

A = Door Opening
B = Fixed Panel

Size	A	B
1000	360	380
1100	410	430
1200	460	480
1400	560	580
1700	560	880

1 Door Quadrants



1 Door Offset Quadrant



1 Door Quadrant

Product Details

Extension profiles available see page 62

Size	Adjustment (Min-Max)	Code	Price £ Exc. VAT	Price £ Inc. VAT
900	850-880	DWH03DH	1101.09	1321.31
1000 x 800	750-780 / 950-980	DWH03BH	1140.95	1369.14
1200 x 800	750-780 / 1150-1180	DWH03CH	1140.95	1369.14
1200 x 900	850-880 / 1150-1180	DWH03EH	1140.95	1369.14

Features

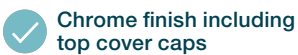
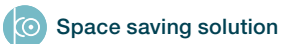
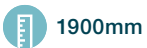

Technical Details

1 Door Quadrant

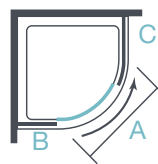

Size	A	B	C
900	450	330	460

1 Door Offset Quadrant

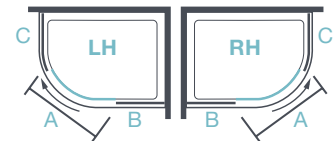

Size	A	B	C
1000 x 800	394	430	430
1200 x 800	394	630	430
1200 x 900	450	630	460

A = Door Opening
B = Straight Panel
C = Curved Panel

Essence Framed

2 Door Quadrants



2 Door Quadrant

Product Details

Extension profiles available see page 62

Features



-  1900mm
-  Space saving solution
-  Reversible
-  Concealed fixing
-  Chrome finish including top cover caps

Size	Adjustment (Min-Max)	Code	Price £ Exc. VAT	Price £ Inc. VAT
800	750-780	DWH02A0	994.74	1193.69
900	850-880	DWH02B0	994.74	1193.69
1000	950-980	DWH02CH	1127.61	1353.13

Technical Details

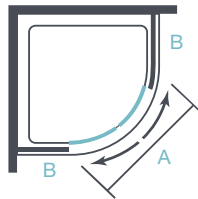

Size	A	B
800	370	180
900	520	280
1000	520	380

A = Door Opening
B = Fixed Panel

Bifold Door



Bifold Door with Side Panel

Product Details

Extension profiles available see page 62

Size	Adjustment (Min-Max)	Code	Price £ Exc. VAT	Price £ Inc. VAT
760	690-750	DWH00B0	763.17	915.81
800	730-790	DWH00C0	763.17	915.81
900	830-890	DWH00D0	806.09	967.31
1000	930-990	DWH00E0	917.96	1101.55

Optional Side Panel

760	720-750	DWH07B0	370.56	444.67
800	760-790	DWH07D0	370.56	444.67
900	860-890	DWH07E0	436.91	524.29

Features

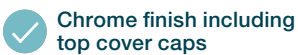
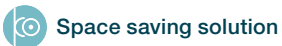
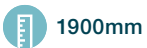

Technical Details

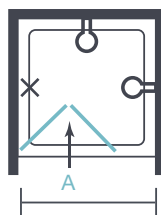

Size	A
760	436
800	476
900	576
1000	626

A = Door Opening

Pivot Door

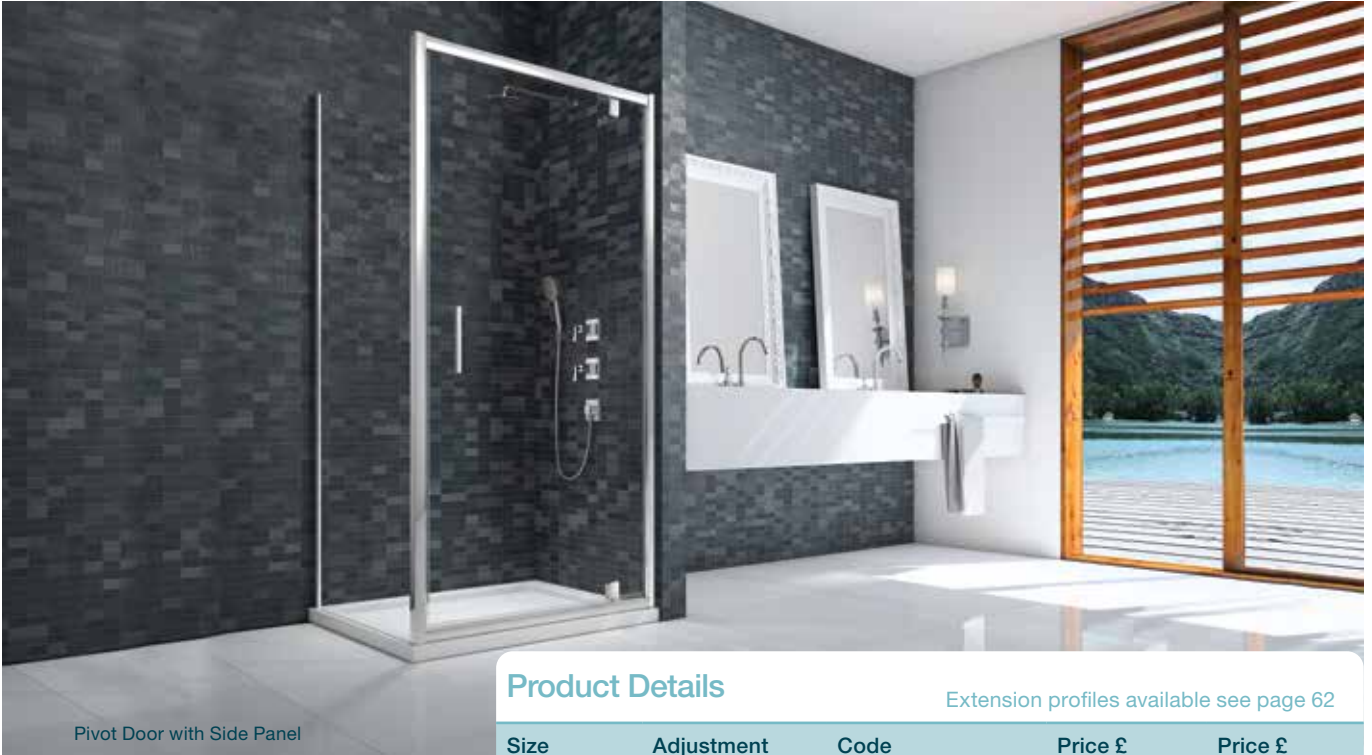

Pivot Door with Side Panel

Product Details

Extension profiles available see page 62

Size	Adjustment (Min-Max)	Code	Price £ Exc. VAT	Price £ Inc. VAT
760	690-750	DWH06B0	662.81	795.37
800	730-790	DWH06D0	702.65	843.18
900	830-890	DWH06E0	729.14	874.97
Optional Side Panel				
760	720-750	DWH07B0	370.56	444.67
800	760-790	DWH07D0	370.56	444.67
900	860-890	DWH07E0	436.91	524.29

Features



- 1900mm
- Concealed fixing
- Reversible
- Chrome finish including top cover caps
- Coloured matching chrome magnetic seals
- Solid "Clunk" close

Technical Details

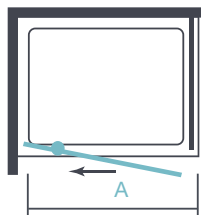

Size	A
760	433
800	473
900	573

A = Door Opening

Wetroom Panels

Flexibility for your Space

The Ionic range of Wetroom Panels offer you the choice to mix and match many combinations of shapes and sizes to any space you require. At MERLYN Ionic, we understand that every wetroom space is different, which is why we have designed a modular system of wetroom panels that can be combined to fit any area. We have broken the range down to 17 key components with additional fitting options which you can build together to make up the full wetroom of your choice. It's as simple as A, B, C.



Features

- Height 2015mm (including rail)
- Reversible
- Optional vertical post, swivel panel and cube panel available
- All panels from 700 and above come with a 1000mm stabilising bar
- New corner profile option available
- Suitable for recess or corner situation
- Swivel panel can be retrofitted to any 8mm shower wall
- 3M support post can be retro-fitted to glass thicknesses of 6mm, 8mm and 10mm

Minimum Opening

We recommend a minimum opening of 500mm for any wetroom area.

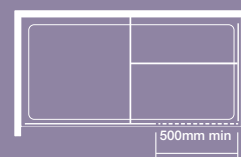

Wetroom Panels

Diagram Ref	Size	Adjustment Min-Max	Order	Price £ Exc. VAT	Price £ Inc. VAT
A	300**	275-290	A0409J0	346.49	415.79
B	400**	375-390	A0409K0	360.99	433.19
C	500**	475-490	A0409L0	375.48	450.58
D	600**	575-590	A0409M0	389.98	467.98
E	700*	675-690	A0409A0	424.19	509.03
F	760*	735-750	A0409N0	424.19	509.03
G	800*	775-790	A0409B0	424.19	509.03
H	900*	875-890	A0409C0	424.19	509.03
I	1000	975-990	A0409D0	460.59	552.71
J	1100	1075-1090	A0409F0	495.39	594.46
K	1200	1175-1190	A0409E0	495.39	594.46
L	1400	1375-1390	A0409G0	578.33	694.00
M	1600	1575-1590	A0409H0	650.95	781.14
N	200	Swivel Panel	A0413H0	236.31	283.57
O	300	Swivel Panel	A0413G0	246.89	296.27
P	400	Swivel Panel	A0413J0	266.76	320.11
Q	300	Cube Panel	A0413F0	217.88	261.45

*Please Note: Panels A-H are the only panels that can be used as an end panel.

**Please Note: Panels A-D do not come with a stabilising bar / Panels E-M come with stabilising bar.

Fitting Options

	Size	Product	Order	Price £ Exc. VAT	Price £ Inc. VAT
R	350	Angled stabilising bar	SP08SCU12320	136.00	163.20
S	400	Vertical ceiling bracing bar	CBB440	191.33	229.60
T	1000	8mm round stabilising bar	A0417A0	156.89	188.26
U	1500	8mm extended stabilising bar	A0S0105	312.71	375.26
V	-	Round T Piece bracket	A04S0010	61.65	73.98
W	2000	Corner profile	A04S0003	63.32	75.98
X	3000	Vertical Post	A0417C0	213.75	256.50

How it Works

If you wanted to make up a Walk In Wetroom for an area to fit on to a 1200mm x 800mm tray or floor. You pick a panel (700mm) and a panel (800mm), this also includes the recommended 500mm minimum opening for the Walk In.

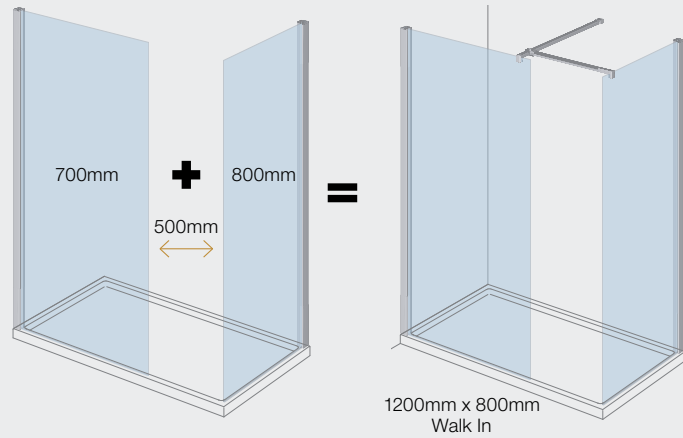

Wetroom Panel



Wetroom Panel with Swivel Panel & Stabilising Bar



Wetroom Panel with Vertical Post



Wetroom Cube Panel with End Panel



Wetroom with End Panel



Corner Wetroom Panel

Fitting Options



Express



The Ultimate Easy-fit Solution

The ultimate easy-fit shower enclosure system. Express by name, express by nature. With innovation at its core, the Ionic Express range has been designed with you in mind, this range has a unique easy-fit system which makes it the easiest fit on the market.

Many of the pieces in this range come pre-assembled to save you time and effort. Not only is this range easy-fit, it has been developed to the highest quality standards while maintaining a stylish contemporary look and feel.



Watch our online fast fit demo

Features

- ✓ Unique easy fit system
- ✓ Height 1900mm
- ✓ Reversible*
*Low Level Access Sliding Door is handed
- ✓ Low Level Sliding Door is compatible with wetroom and tray situations
- ✓ Quick release easy clean double rollers
- ✓ Fixed panels come pre-assembled to wall profile
- ✓ All rollers come pre-assembled on moving panels
- ✓ Additional inline panels available to fit awkward spaces

03 Easy Fit Steps



Step 01
Slot and connect frame in place.



Step 02
Slide mechanism to secure profile at each corner.

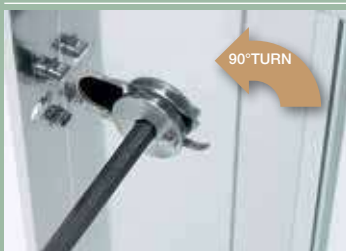

Step 03
Quarter turn to lock wall and upright profiles in place, without the need for drilling through aluminium.

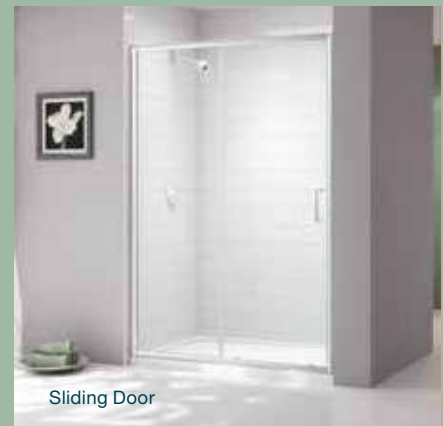

Sliding Door



Pivot Door



Low Level Access Sliding Door

Low Level Access Sliding Door

At MERLYN we are constantly striving to provide solutions for our customers. With future-proofing being an essential part of bathroom planning, we are excited to showcase our **IONIC Express Low Level Sliding Door**. This enclosure allows easy access for users on both wetroom and tray situations - no more stepping required.

With the same great benefits as our standard IONIC Express Sliding Door – easy cleaning and increased water retention – this door offers a new solution with the same great quality you can expect from MERLYN.



Bifold Door

Express by Name Express by Nature

With innovation at its core, the Ionic Express range has been designed with a unique easy-fit system which makes it the easiest fit on the market.



2 Door Quadrants



1 Door Quadrant

03

Easy Fit Steps

The Easy Fit Range means less drilling and less screws. For installation instructions see page 42.

Express

Sliding Door

Low Level Access



Sliding Door in a Recess shown as Left hand



Sliding Door with Side Panel shown as Right hand

Product Details

Extension profiles available see page 62

Size	Recess Adjustment (Min-Max)	Side Panel Adjustment (Min-Max)	Handed	Code	Price £ Exc. VAT	Price £ Inc. VAT
1000	950-990	960-1000	Left	A0303A0	739.88	887.86
1000	950-990	960-1000	Right	A0303B0	739.88	887.86
1200	1150-1190	1160-1200	Left	A0303G0	739.88	887.86
1200	1150-1190	1160-1200	Right	A0303H0	739.88	887.86
1400	1350-1390	1360-1400	Left	A0303LH	952.38	1142.86
1400	1350-1390	1360-1400	Right	A0303MH	952.38	1142.86
1700	1650-1690	1660-1700	Left	A0303SH	1050.11	1260.13
1700	1650-1690	1660-1700	Right	A0303TH	1050.11	1260.13

Optional Side Panel

700	650-670	A0307A0	396.36	475.63
760	710-730	A0307B0	396.36	475.63
800	750-770	A0307D0	396.36	475.63
900	850-870	A0307E0	437.00	524.40

Ionic Express Inline Panel (For more details see page 63)

150	130-150	A0315B0	330.05	396.06
210	190-210	A0315C0	330.05	396.06
490	470-490	A0315D0	385.87	463.05

Technical Details

Size	A	B
1000	376	433
1200	476	533
1400	576	633
1700	576	933

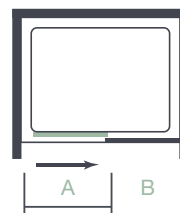

A = Door Opening
B = Fixed Panel

Features



1900mm



Easy-fit system



Door Handed

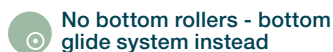

No bottom rollers - bottom glide system instead

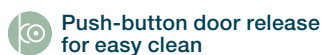

Push-button door release for easy clean

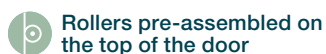

Rollers pre-assembled on the top of the door

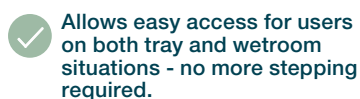

Allows easy access for users on both tray and wetroom situations - no more stepping required.

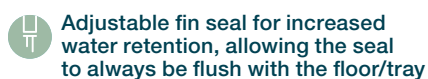

Adjustable fin seal for increased water retention, allowing the seal to always be flush with the floor/tray

03

Easy Fit Steps

The Easy Fit Range means less drilling and less screws. For installation instructions see page 42.

Express

Sliding Door



Sliding Door in a Recess



Sliding Door with Inline Panel in a Recess



Sliding Door with Side Panel

Product Details

Extension profiles available see page 62

Size	Adjustment (Min-Max)	Code	Price £ Exc. VAT	Price £ Inc. VAT
1000	950-990	A0304A0	643.50	772.20
1100	1050-1090	A0304B0	643.50	772.20
1200	1150-1190	A0304C0	643.50	772.20
1400	1350-1390	A0304DH	827.87	993.44
1500	1450-1490	A0304GH	881.27	1057.52
1600	1550-1590	A0304EH	901.60	1081.92
1700	1650-1690	A0304HH	912.72	1095.26

Features



20 YEARS GUARANTEE



MERSHIELD STAYCLEAR



6^{MM} GLASS THICKNESS

1900mm

Easy-fit system

Reversible

Smooth action extra strong rollers

Concealed fixing

Easy clean quick release rollers

Double fin seal for increased water retention

Rollers pre-assembled on door

Optional Side Panel (Please Note: Add 10mm to the a above adjustment when fitted with optional Side Panel)

700	650-670	A0307A0	396.36	475.63
760	710-730	A0307B0	396.36	475.63
800	750-770	A0307D0	396.36	475.63
900	850-870	A0307E0	437.00	524.40

Ionic Express Inline Panel (For more details see page 63)

150	130-150	A0315B0	330.05	396.06
210	190-210	A0315C0	330.05	396.06
490 (New)	470-490	A0315D0	385.87	463.05

For Inline Panel size calculations please see page 63.

Please Note: Sliding Door can be paired with 2 additional Side Panels.

Technical Details

Size	A	B
1000	380	433
1100	430	483
1200	480	533
1400	580	633
1500	580	733
1600	580	833
1700	580	933

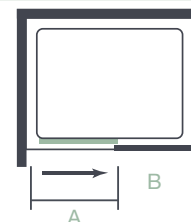

A = Door Opening
B = Fixed Panel

01

Easy Fit Step

The Easy Fit Range means less drilling and less screws. For installation instructions see page 42.

Express

Pivot Door



Pivot Door with Inline Panel & Side Panel

Pivot Door with Side Panel

Pivot Door in a Recess

Product Details

Extension profiles available see page 62

Size	Adjustment (Min-Max)	Code	Price £ Exc. VAT	Price £ Inc. VAT
700	650-690	A0306A0	549.43	659.32
760	710-750	A0306B0	549.43	659.32
800	750-790	A0306D0	549.43	659.32
900	850-890	A0306E0	632.36	758.84
1000	950-990	A0306G0	696.88	836.25

Optional Side Panel (Please Note: Add 10mm to the above adjustment when fitted with optional Side Panel)

700	650-670	A0307A0	396.36	475.63
760	710-730	A0307B0	396.36	475.63
800	750-770	A0307D0	396.36	475.63
900	850-870	A0307E0	437.00	524.40

Ionic Express Inline Panel (For more details see page 63)

150	130-150	A0315B0	330.05	396.06
210	190-210	A0315C0	330.05	396.06
490 (new)	470-490	A0315D0	385.87	463.05

For Inline Panel size calculations please see page 63.

Features



1900mm

Easy-fit system

Reversible

Concealed fixing

20mm adjustment per wall profile

Technical Details

Size	A	B
700	415	390
760	475	450
800	515	490
900	615	590
1000	715	690

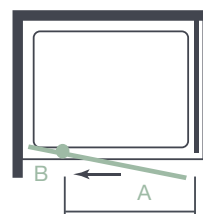

A = Door Opening
B = Door Swing

01

Easy Fit Step

The Easy Fit Range means less drilling and less screws. For installation instructions see page 42.

Bifold Door



Bifold Door in a Recess



Bifold Door with Inline Panel in a Recess



Bifold Door with Side Panel

Product Details

Extension profiles available see page 62

Size	Adjustment (Min-Max)	Code	Price £ Exc. VAT	Price £ Inc. VAT
760	710-750	A0300B0	615.90	739.08
800	750-790	A0300C0	615.90	739.08
900	850-890	A0300D0	658.18	789.81
1000	950-990	A0300E0	765.11	918.13

Optional Side Panel (Please Note: Add 10mm to the above adjustment when fitted with optional Side Panel)

700	650-670	A0307A0	396.36	475.63
760	710-730	A0307B0	396.36	475.63
800	750-770	A0307D0	396.36	475.63
900	850-870	A0307E0	437.00	524.40

Ionic Express Inline Panel (For more details see page 63)

150	130-150	A0315B0	330.05	396.06
210	190-210	A0315C0	330.05	396.06
490 (New)	470-490	A0315D0	385.87	463.05

For Inline Panel size calculations please see page 63.

Technical Details

Size	A
760	475
800	515
900	615
1000	715

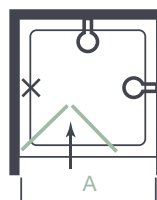

A = Door Opening

Features



20 YEARS GUARANTEE



MERSHIELD STAYCLEAR



6^{MM} GLASS THICKNESS

1900mm

Easy-fit system

Reversible

Concealed fixing

Discreet chrome bifold hinge

20mm adjustment per wall profile

03

Easy Fit Steps

The Easy Fit Range means less drilling and less screws. For installation instructions see page 42.

Express

2 Door Quadrants



2 Door Quadrant

Product Details

Extension profiles available see page 62

Features



20 YEARS GUARANTEE



MERSHIELD STAYCLEAR



6^{MM} GLASS THICKNESS

1900mm

Easy-fit system

Reversible

Concealed fixing

Double fin seal for increased water retention

Easy clean quick release rollers

Smooth action extra strong rollers

Rollers pre-assembled on door

Size	Adjustment (Min-Max)	Code	Price £ Exc. VAT	Price £ Inc. VAT
2 Door Offset Quadrant				
900 x 760	855-875 / 715-735	A0302C0	827.87	993.44
1000 x 800	955-975 / 755-775	A0302D0	901.60	1081.92
1200 x 800	1155-1175 / 755-775	A0302HH	1045.49	1254.59
1200 x 900	1155-1175 / 855-875	A0302IH	1078.56	1294.27
2 Door Quadrant				
800	755-775	A0302A0	735.61	882.73
900	855-875	A0302B0	735.61	882.73

Technical Details

Size	A	B	C
2 Door Offset Quadrant			
900 x 760	430	321	181
1000 x 800	465	421	221
1200 x 800	465	621	221
1200 x 900	540	621	321
2 Door Quadrant			
800	390	221	
900	540	321	

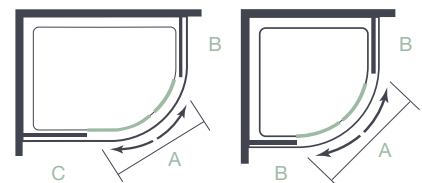

A = Door Opening
B = Fixed Panel
C = Fixed Panel

03

Easy Fit Steps

The Easy Fit Range means less drilling and less screws. For installation instructions see page 42.

Express

1 Door Quadrant



1 Door Quadrant

Product Details

Extension profiles available see page 62

Size	Adjustment (Min-Max)	Code	Price £ Exc. VAT	Price £ Inc. VAT
900	855-875	A0301B0	901.60	1081.92

Features



- 1900mm
- Easy-fit system
- Reversible
- Concealed fixing
- Double fin seal for increased water retention
- Easy clean quick release rollers
- Smooth action extra strong rollers
- Rollers pre-assembled on door

Technical Details

Size	A	B	C
900	460	526	321

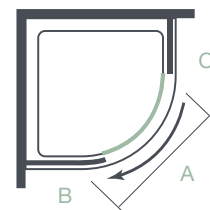

A = Door Opening
B = Fixed Panel
C = Fixed Panel

Source

Affordable Shower Enclosures

Ionic Source is our exciting range of affordable 6mm shower enclosures created by MERLYN. This range has been developed to offer our customers an exceptional quality shower enclosure without the hefty price tag.

Ionic Source has a fresh, contemporary look and feel. With simple clean lines, these showers will remain timeless for years to come. Standing at 1850mm high with 6mm* toughened glass with easy fit frame, robust quick release easy clean rollers, secure clunk closing and discreet modern fittings, the attention to detail and emphasis on quality is clearly evident throughout this range.

03 Easy Fit Steps

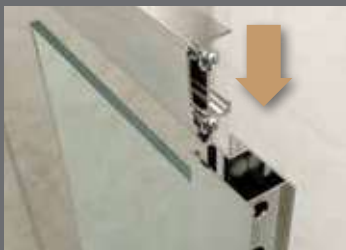

Step 01
Align the horizontal and vertical profiles together.



Step 02
Slot the horizontal profile and screws into upright using guide channel until flush.

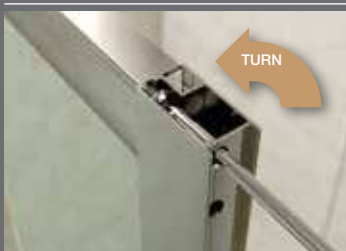

Step 03
Secure screws into position using dedicated access holes.

*Bifold door has 4mm glass



Sliding Door



2 Door Quadrants



Pivot Door

**Quality Without
the Hefty Price-Tag**

With our new 3 step pre-assembled frames the Ionic Source range is now easier and quicker to install than ever before.



Bifold Door



Corner Door

Source

Sliding Door



Chrome Handle



Sliding Door in a Recess

Product Details

Extension profiles available see page 62

Size	Adjustment (Min-Max)	Code	Price £ Exc. VAT	Price £ Inc. VAT
1000	950-990	A1204A0	363.50	436.20
1100	1050-1090	A1204B0	363.50	436.20
1200	1150-1190	A1204C0	378.07	453.68

20mm Adjustment per wall profile.

Optional Side Panels				
Size	Adjustment (Min-Max)	Code	Price £ Exc. VAT	Price £ Inc. VAT
760	730-750	A1207B0	217.47	260.96
800	770-790	A1207D0	217.47	260.96
900	870-890	A1207E0	232.02	278.43

Technical Details

Size	A	B
1000	380	400
1100	430	450
1200	480	500

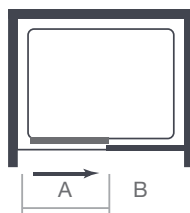

A = Door Opening
B = Fixed Panel

Features



- 1850mm
- Chrome quick release easy clean bottom rollers
- Reversible
- Easy fit frame
- Screw cover caps
- Magnetic seals

Source

2 Door Quadrants



2 Door Offset Quadrant

Product Details

Extension profiles available see page 62

Features



- 1850mm
- Chrome quick release easy clean bottom rollers
- Reversible
- Easy fit frame
- Fixing cover caps
- Magnetic seals

Size	Adjustment (Min-Max)	Code	Price £ Exc. VAT	Price £ Inc. VAT
------	----------------------	------	------------------	------------------

800	770-790	A1202A0	363.50	436.20
900	870-890	A1202B0	363.50	436.20

2 Door Offset Quadrants

Size	Adjustment (Min-Max)	Code	Price £ Exc. VAT	Price £ Inc. VAT
------	----------------------	------	------------------	------------------

1000 x 800	970-990 / 770-790	A1202D0	494.85	593.82
1200 x 800	1170-1190 / 770-790	A1202HH	509.40	611.28
1200 x 900	1170-1190 / 870-890	A1202IH	523.97	628.76

20mm Adjustment per wall profile.

Technical Details

Size	A	B	C
800	400	210	210
900	540	310	310
1000 x 800	470	410	210
1200 x 800	470	610	210
1200 x 900	540	610	310

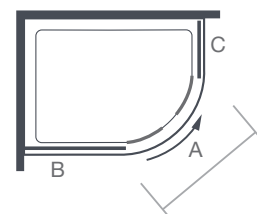

A = Door Opening
B = Fixed Panel
C = Fixed Panel

Source

Pivot Door



Product Details

Extension profiles available see page 62

Size	Adjustment (Min-Max)	Code	Price £ Exc. VAT	Price £ Inc. VAT
760	710-750	A1206B0	290.40	348.48
800	750-790	A1206D0	319.67	383.60
900	850-890	A1206E0	348.79	418.55

20mm adjustment per wall profile.

Optional Side Panels

760	730-750	A1207B0	217.47	260.96
800	770-790	A1207D0	217.47	260.96
900	870-890	A1207E0	232.02	278.43

Technical Details

Size	A	B
760	490	460
800	530	500
900	630	600

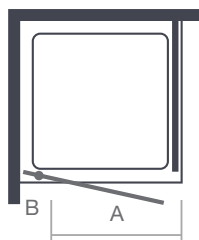

A = Door Opening
B = Door Swing

Features



- 1850mm
- Reversible
- Minimalist pivot
- Pre-assembled frame
- Screw cover caps
- Magnetic seals

Source

Bifold Door



Product Details

Extension profiles available see page 62

Size	Adjustment (Min-Max)	Code	Price £ Exc. VAT	Price £ Inc. VAT
700	650-690	A1200A0	348.79	418.55
760	710-750	A1200B0	348.79	418.55
800	750-790	A1200C0	363.50	436.20
900	850-890	A1200D0	378.07	453.68





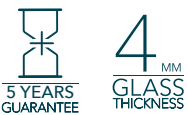

20mm Adjustment per wall profile.

Optional Side Panels

760	730-750	A1207B0	217.47	260.96
800	770-790	A1207D0	217.47	260.96
900	870-890	A1207E0	232.02	278.43

Features



-  1850mm
-  Reversible
-  Pre-assembled frame
-  Smooth running action
-  Screw cover caps
-  Magnetic seals

Technical Details

Size	A
700	400
760	460
800	500
900	600

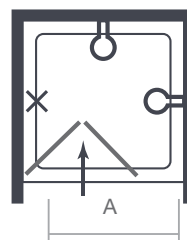

A = Door Opening

Source

Corner Door



Adjustable corner bracket

Product Details

Extension profiles available see page 62

Size	Adjustment (Min-Max)	Code	Price £ Exc. VAT	Price £ Inc. VAT
760/800	740-790	A1212V0	494.85	593.82
900	870 -890	A1212B0	509.40	611.28

20mm adjustment per wall profile.

Technical Details

Size	A	B
760/800	350-390	300
900	460	350

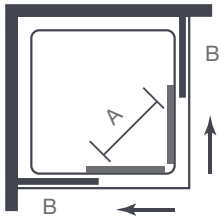

A = Door opening
B = Fixed panel

Features



5 YEARS GUARANTEE



6^{MM} GLASS THICKNESS

- 1850mm
- Reversible
- Chrome quick release easy clean bottom rollers
- Easy fit frame
- Screw cover caps
- Magnetic seals



SecureSeal.

by MERLYN

How SecureSeal works

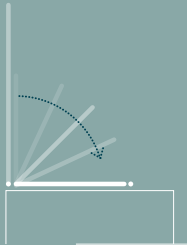

01.
Pull down arm from storage position.

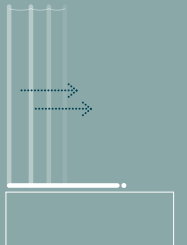

02.
Extend screen and locate panels.

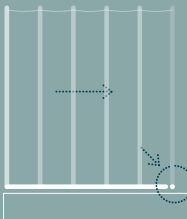

03.
Fully extend and clip into position for a secure fit and tight seal.

The Ultimate Leak-free Bath Screen

The SecureSeal by MERLYN has been designed with a leak free sealing arm which extends from the profile to create a complete seal between the bath and screen. When not in use the arm simply folds away back into the profile.

SecureSeal by MERLYN offers functional and easy to use designs to complement any bathroom space. With glass screen heights of 1500mm and 6mm glass, our SecureSeal by MERLYN range allows you to enjoy peace of mind in a leak free shower experience for years to come.

This range has been designed with the same superb materials and unrelenting attention to detail demonstrated across all MERLYN ranges.





Single Panel				
Size	Adjustment	Code	Price £ Exc. VAT	Price £ Inc. VAT
800 x 1500	780-800	MS1	335.75	402.90

Optional SecureSeal Fixed Panel				
Size	Adjustment	Code	Price £ Exc. VAT	Price £ Inc. VAT
300 x 1500	300-320	MSFP	265.59	318.70

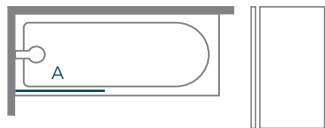

Single Panel Configuration

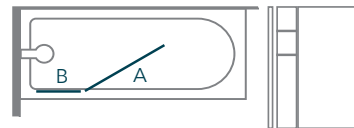

Single Fixed Panel Configuration

A: Moving Panels (screen width when folded into the bath 712mm) B: Fixed Panel
 Recommended shower head position



4 Fold				
Size	Adjustment	Code	Price £ Exc. VAT	Price £ Inc. VAT
800 x 1500	780-800	MS4	560.54	672.65

Optional SecureSeal Fixed Panel				
Size	Adjustment	Code	Price £ Exc. VAT	Price £ Inc. VAT
300 x 1500	300-320	MSFP	265.59	318.70



A: Moving Panels (screen width when folded into the bath 228mm)
 Recommended shower head position



5 Fold				
Size	Adjustment	Code	Price £ Exc. VAT	Price £ Inc. VAT
1000 x 1500	980-1000	MS5	630.86	757.04

Optional SecureSeal Fixed Panel				
Size	Adjustment	Code	Price £ Exc. VAT	Price £ Inc. VAT
300 x 1500	300-320	MSFP	265.59	318.70



A: Moving Panels (screen width when folded into the bath 228mm)
 Recommended shower head position





Bath Screens



Simple Shapes

Ionic Bath Screens are the perfect solution for in-bath showering. Innovative design and contemporary aesthetics bring this bathroom favourite to life with modern shapes and features to enjoy for years to come

HydraSEAL

HydraSEAL creates a barrier to restrict leaking!



We have created an exciting new feature, exclusive to MERLYN Bath Screens called HydraSEAL

HydraSEAL acts as an extra barrier, sealing the gap between the seal and the pivot point where water can usually escape.

It contains a high density foam that compresses onto the bath screen to form a tight seal and restricts water escaping from this problem area.

HydraSEAL is now available on our MB1, MB2, MB2t, MB3, MB3a and MB3b, MB3c bath screens.

Bath Screens up to 6mm



MB12
Bathscreen

5mm
GLASS
THICKNESS
LIFETIME
GUARANTEE

Pivot Square

Size	Panel	Code	Price £ Exc. VAT	Price £ Inc. VAT
800 x 1400	1	MB12	168.53	202.23

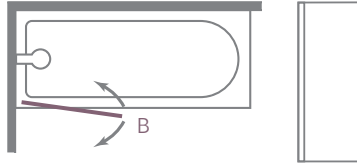

Door Swing: 90° in and out

B: Radius of Screen Swing = 735mm

○ Recommended shower head position



MB0
Bathscreen

6mm
GLASS
THICKNESS
LIFETIME
GUARANTEE

Fixed Square

Size	Panel	Code	Price £ Exc. VAT	Price £ Inc. VAT
800 x 1500	1	MB0	159.92	191.91

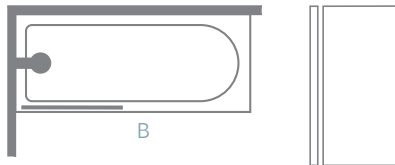

○ Recommended shower head position



MB1
Bathscreen

6mm
GLASS
THICKNESS
LIFETIME
GUARANTEE

Single Curved

Size	Panel	Code	Price £ Exc. VAT	Price £ Inc. VAT
800x1500	1	MB1	218.27	261.92

Compatible with Easy-Fit MB1 FLEX

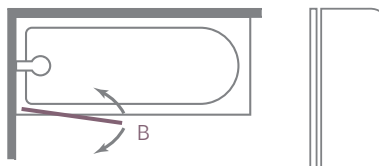

Door Swing: 90° in and out

B: Radius of Screen Swing = 733mm

○ Recommended shower head position

Now featuring
HydraSEAL



MB2
Bathscreen

6mm GLASS THICKNESS
LIFETIME GUARANTEE
MERSEFIELD STAYCLEAR

Now featuring
HydraSEAL

Single Square

Size	Panel	Code	Price £ Exc. VAT	Price £ Inc. VAT
800 x 1500	1	MB2	258.20	309.85

Compatible with Easy-Fit MB2FLEX

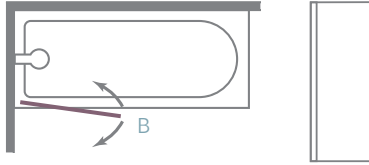

Door Swing: 90° in and out
B: Radius of Screen Swing = 733mm
 ☉ Recommended shower head position



MB2
Bathscreen

6mm GLASS THICKNESS
LIFETIME GUARANTEE
MERSEFIELD STAYCLEAR

Now featuring
HydraSEAL

Single Square Panel

Size	Panel	Code	Price £ Exc. VAT	Price £ Inc. VAT
1500 x 800	1	MB2T	324.30	389.16

Includes Towel Rail

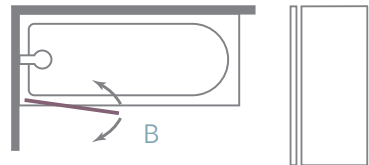

Door Swing: 90° in and out
B: Radius of Screen Swing = 733mm
 ☉ Recommended shower head position



MB3
Bathscreen

6mm GLASS THICKNESS
LIFETIME GUARANTEE
MERSEFIELD STAYCLEAR

Now featuring
HydraSEAL

2 Panel Curved

Size	Panel	Code	Price £ Exc. VAT	Price £ Inc. VAT
1150 x 1500	2	MB3	610.16	732.20

Compatible with Easy-Fit MB3FLEX

Includes Towel Rail

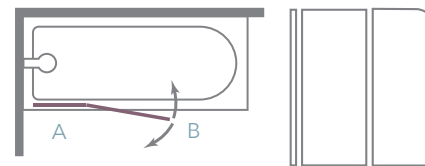

Door Swing: 90° in and out
A: Fixed Panel **B:** Radius of Screen Swing = 733mm
 ☉ Recommended shower head position

Bath Screens up to 6mm



2 Panel Folding Curved

Size	Panel	Code	Price £ Exc. VAT	Price £ Inc. VAT
900 x 1500	2	MB3A	360.68	432.82

Compatible with Easy-Fit MB3AFLEX

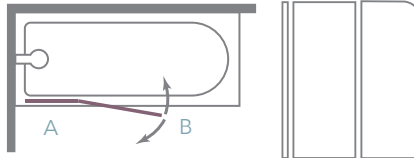

Door Swing: 90° in and out

A: Fixed Panel B: Radius of Screen Swing = 483mm

☐ ○ Recommended shower head position



2 Panel Folding Square

Size	Panel	Code	Price £ Exc. VAT	Price £ Inc. VAT
900 x 1500	2	MB3B	360.68	432.82

Compatible with Easy-Fit MB3BFLEX

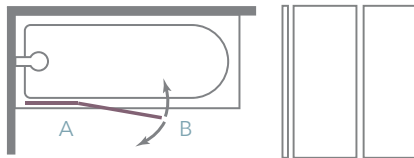

Door Swing: 90° in and out

A: Fixed Panel B: Radius of Screen Swing = 483mm

☐ ○ Recommended shower head position



2 Panel Hinged

Size	Panel	Code	Price £ Exc. VAT	Price £ Inc. VAT
900 x 1500	2	MB3C	360.68	432.82

Compatible with Easy-Fit MB3CFLEX

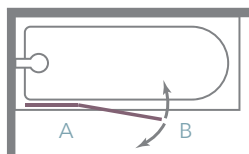

Door Swing: 90° in and out

A: Fixed Panel = 471mm

B: Radius of Screen Swing = 383mm

☐ ○ Recommended shower head position



MB4
Bathscreen



4 Fold				
Size	Panel	Code	Price £ Exc. VAT	Price £ Inc. VAT
850 x 1400	4	MB4	428.47	514.16

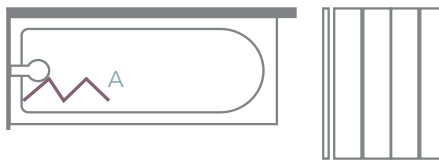

A: Moving Panels (Panel width 200mm)
 Recommended shower head position



MB5
Bathscreen



Curtain Rail				
Size	Panel	Code	Price £ Exc. VAT	Price £ Inc. VAT
300 x 1500	1	MB5	287.09	344.51



Height is 1550mm including rail
A: Fixed Panel B: Curtain Rail
 Recommended shower head position



MB5a
Bathscreen



Curtain Rail				
Size	Panel	Code	Price £ Exc. VAT	Price £ Inc. VAT
300 x 1800	1	MB5A	287.09	344.51

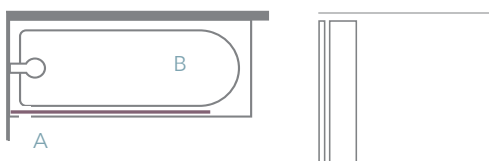

Height is 1800mm including rail
A: Fixed Panel B: Curtain Rail
 Recommended shower head position

Bath Screens 6 - 8mm



2 Panel Folding

Size	Panel	Code	Price £ Exc. VAT	Price £ Inc. VAT
1100 x 1500	2	MB13	565.03	678.03

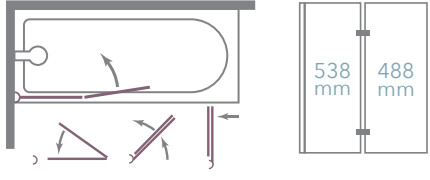

Screen Swing: 180° in and out
 ○ Recommended shower head position



Hinged Square

Size	Panel	Code	Price £ Exc. VAT	Price £ Inc. VAT
850 x 1500	1	MB6	573.93	688.72

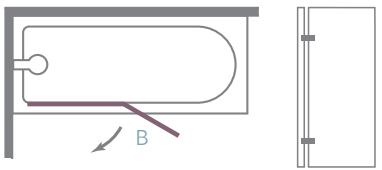

Door Swing: 90° outward swing only
 B: Radius of Screen Swing = 810mm
 ○ Recommended shower head position



2 Panel Hinged

Size	Panel	Code	Price £ Exc. VAT	Price £ Inc. VAT
900 x 1500	2	MB7L (L/H)	699.54	839.45
900 x 1500	2	MB7R (R/H)	699.54	839.45

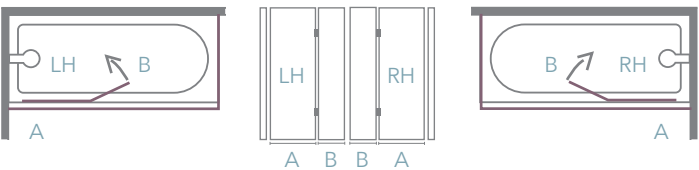

Door Swing: 180 Degrees inwards only
 A: Fixed Panel = 497mm
 B: Radius of Screen Swing = 383mm
 ○ Recommended shower head position



MB7a
Bathscreen

8mm GLASS THICKNESS
LIFETIME GUARANTEE
MERSEFIELD STAYCLEAR

2 Panel Hinged

Size	Panel	Code	Price £ Exc. VAT	Price £ Inc. VAT
850 x 1500	2	MB7AL (L/H)	672.66	807.19
850 x 1500	2	MB7AR (R/H)	672.66	807.19

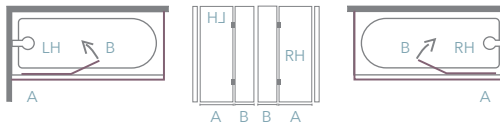

Door Swing: 180 Degrees inwards only

A: Fixed Panel = 505mm

B: Radius of Screen Swing = 383mm

○ Recommended shower head position



MB8
Bathscreen

8mm GLASS THICKNESS
LIFETIME GUARANTEE
MERSEFIELD STAYCLEAR

2 Panel Folding

Size	Panel	Code	Price £ Exc. VAT	Price £ Inc. VAT
1100x1500	2	MB8	695.76	834.91

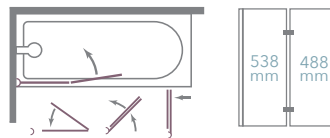

Door Swing: 180 degree radius of screen swing inwards and outwards

○ Recommended shower head position



MB9
Bathscreen

8mm GLASS THICKNESS
LIFETIME GUARANTEE
MERSEFIELD STAYCLEAR

3 Panel Folding

Size	Panel	Code	Price £ Exc. VAT	Price £ Inc. VAT
1400 x 1500	3	MB9	870.08	1044.10

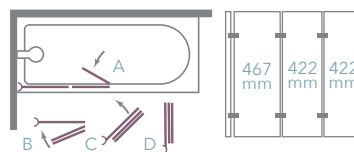

Door Swing: 180 degree radius of screen swing inwards and outwards

○ Recommended shower head position



MB10
Bathscreen

8mm GLASS THICKNESS
LIFETIME GUARANTEE
MERSEFIELD STAYCLEAR

Single Square

Size	Panel	Code	Price £ Exc. VAT	Price £ Inc. VAT
800 x 1500	1	MB10	565.03	678.03

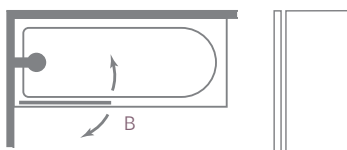

Door Swing: 90° in and out

B: Radius of Screen Swing = 740mm

○ Recommended shower head position

Bath Screens 8mm



MB11
Bathscreen



Single Curved Panel				
Size	Panel	Code	Price £ Exc. VAT	Price £ Inc. VAT
800 x 1500	1	MB11	494.22	593.07

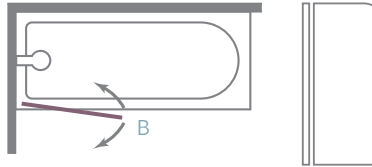

Door Swing: 90° in and out
B: Radius of Screen Swing = 733mm
 ☐ Recommended shower head position



MB14
Bathscreen



Fixed Square Panel				
Size	Panel	Code	Price £ Exc. VAT	Price £ Inc. VAT
800x1500	1	MB14	281.80	338.16

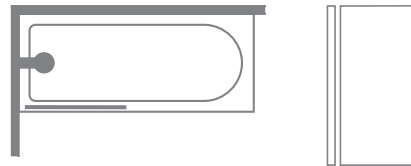

Fixed Panel
 ☐ Recommended shower head position

Easy-Fit Bundles

Single Curved

Size	Panel	Code	Price £ Exc. VAT	Price £ Inc. VAT
800 x 1500		MB1FLEX	279.31	335.17

Single Square

Size	Panel	Code	Price £ Exc. VAT	Price £ Inc. VAT
800 x 1500		MB2FLEX	317.67	381.20

2 Panel Curved

Size	Panel	Code	Price £ Exc. VAT	Price £ Inc. VAT
1150 X 1500		MB3FLEX	656.06	787.27

2 Panel Folding Curved

Size	Panel	Code	Price £ Exc. VAT	Price £ Inc. VAT
900 x 1500		MB3AFLEX	416.18	499.42

2 Panel Folding Square

Size	Panel	Code	Price £ Exc. VAT	Price £ Inc. VAT
900 x 1500		MB3BFLEX	416.18	499.42

2 Panel Hinged

Size	Panel	Code	Price £ Exc. VAT	Price £ Inc. VAT
900 x 1500		MB3CFLEX	416.18	499.42

MERLYN

EASY-FIT

An innovative way to replace your bath screen without the need to re-drill the wall. Simply connect your easy-fit to the existing holes in the wall and install your new bath screen.

Fitting Steps

Easy-Fit
profile



1

REMOVE THE
OLD PROFILE



2

POSITION THE
EASY-FIT PROFILE
ON THE WALL



*Slide bracket
up to align
with hole*



Scan me to see more

3

ADJUST THE
BRACKETS TO
ALIGN TO THE
EXISTING HOLES
AND FIX IN
POSITION



Available with the MB1 / MB2 / MB3 / MB3A / MB3B and MB3C Bath Screens

TOUCHSTONE-SR

SLIP RESISTANT TRAY

We have carried out all the testing to give you and your family the peace of mind of showering in a safe environment and the splendour of this natural stone effect.



Scan me for more information
on our slip resistant trays.
Level25-SR & Touchstone-SR



Exceeds Class C for DIN 51097 - Barefoot ramp test.
This ranks MERLYN in a premium class.



EASY CLEAN
All you need is a soft cloth
and warm soapy water.

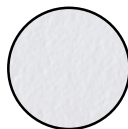

QUALITY LOOK AND FEEL
The luxury satin look and feel is designed to give
confidence while not feeling harsh underfoot.

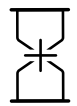

**10 YEARS
GUARANTEE**

TOUCHSTONE Strong and Durable

Features & Benefits

- 10 Year Guarantee
- Single skinned with moulded solid under section
- 50mm high to achieve minimalist design
- Available as low level or with tray panel kits for easy installation
- Antislip is manufactured into the coating and won't wear
- 135mm high including tray panel kit
- Compatible 90mm fast flow waste also available
- The Touchstone tray is capped with an easy to clean surface that provides a chemical resistant, anti-bacterial solution due to it's ultra-smooth, non-porous surface.
- More than 30 sizes available

Slip Resistant Tray

TOUCHSTONE-SR

Rectangular Tray *** WASTE NOT INCLUDED				
Size	Code	Tray Panel Kit	Price £ Exc. VAT	Price £ Inc. VAT
900 x 800	S980RTASTO	Kit 4	251.75	302.10
1000 x 800	S108RTASTO	Kit 4	259.98	311.98
1000 x 900	S109RTASTO	Kit 4	269.95	323.94
1100 x 800	S118RTASTO	Kit 4	269.95	323.94
1200 x 700	S127RTASTO	Kit 4	269.95	323.94
1200 x 760	S1276RTASTO	Kit 4	282.83	339.39
1200 x 800	S128RTASTO	Kit 4	299.80	359.76
1200 x 900	S129RTASTO	Kit 4	321.77	386.12
1400 x 700	S147RTASTO	Kit 3	430.11	516.13
1400 x 800	S148RTASTO	Kit 3	430.11	516.13
1400 x 900	S149RTASTO	Kit 3	453.34	544.01
1500 x 760	S1576RTASTO	Kit 3	504.64	605.56
1500 x 800	S158RTASTO	Kit 3	504.64	605.56
1500 x 900	S159RTASTO	Kit 3	531.18	637.42
1600 x 700	S167RTASTO	Kit 3	563.10	675.72
1600 x 800	S168RTASTO	Kit 3	563.10	675.72
1600 x 900	S169RTASTO	Kit 3	591.24	709.49
1685 x 700	S177RTASTO	Kit 3	610.00	732.00
1700 x 800	S178RTASTO	Kit 3	684.16	820.99
1700 x 900	S179RTASTO	Kit 3	736.94	884.32

*Waste is centred on 1700x800 & 1700x900 trays.

Rectangle Tray Panel Kits – (Including Legs) *** WASTE NOT INCLUDED				
Tray Size	Code	Tray Panel Kit	Price £ Exc. VAT	Price £ Inc. VAT
1700 x 900	DRK3	Kit 3	131.96	158.35
1200 x 900	DRK4	Kit 4	131.96	158.35

Tray Panel Kits (including Legs)*** No Waste			
Tray Panel Kit	Code	Price £ Exc. VAT	Price £ Inc. VAT
Kit 1	DRK1	131.96	158.35
Kit 2	DRK2	131.96	158.35
Kit 3	DRK3	131.96	158.35
Kit 4	DRK4	131.96	158.35

Standard Tray

TOUCHSTONE

Rectangle Tray *** WASTE NOT INCLUDED					
Tray Size	Code	Tray Panel Kit	Price £ Exc. VAT	Price £ Inc. VAT	
800 x 700	S870RTTO	Kit 4	174.01	208.81	
800 x 760	S876RTTO	Kit 4	174.01	208.81	
900 x 700	S970RTTO	Kit 4	190.15	228.18	
900 x 760	S976RTTO	Kit 4	190.15	228.18	
900 x 800	S980RTTO	Kit 4	190.15	228.18	
1000 x 700	S107RTTO	Kit 4	196.35	235.62	
1000 x 760	S1076RTTO	Kit 4	196.35	235.62	
1000 x 800	S108RTTO	Kit 4	196.35	235.62	
1000 x 900	S109RTTO	Kit 4	203.89	244.66	
1100 x 800	S118RTTO	Kit 4	203.89	244.66	
1200 x 700	S127RTTO	Kit 4	203.89	244.66	
1200 x 760	S1276RTTO	Kit 4	213.61	256.33	
1200 x 800	S128RTTO	Kit 4	226.42	271.70	
1200 x 900	S129RTTO	Kit 4	243.00	291.60	
1300 x 800	S138RTTO	Kit 3	315.39	378.47	
1400 x 700	S147RTTO	Kit 3	324.85	389.82	
1400 x 760	S1476RTTO	Kit 3	324.85	389.82	
1400 x 800	S148RTTO	Kit 3	324.85	389.82	
1400 x 900	S149RTTO	Kit 3	342.37	410.85	
1500 x 700	S157RTTO	Kit 3	360.95	433.14	
1500 x 760	S1576RTTO	Kit 3	381.12	457.34	
1500 x 800	S158RTTO	Kit 3	381.12	457.34	
1500 x 900	S159RTTO	Kit 3	401.17	481.40	
1600 x 700	S167RTTO	Kit 3	425.28	510.34	
1600 x 800	S168RTTO	Kit 3	425.28	510.34	
1600 x 900	S169RTTO	Kit 3	446.53	535.84	
1685 x 700	S177RTTO	Kit 3	460.70	552.85	
1680 x 760	S1776RTTO	Kit 3	474.88	569.85	
1700 x 800*	S178RTTO	Kit 3	516.70	620.04	
1700 x 900*	S179RTTO	Kit 3	556.56	667.87	
1800 x 800	S188RTTO	-	630.31	756.38	

*Waste is centred on 1700x800 & 1700x900 trays.

Waste Complete Only		
Code	Price £ Exc. VAT	Price £ Inc. VAT
DWAS	39.06	46.87

Please Note: Price and order codes on the Touchstone-SR and Touchstone do not include waste, waste must be ordered separately. Code: DWAS



Slip Resistant Tray

TOUCHSTONE-SR

Square Tray *** WASTE NOT INCLUDED				
Size	Code	Tray Panel Kit	Price £ Exc. VAT	Price £ Inc. VAT
800 x 800	S80SQASTO	Kit 4	171.54	205.85
900 x 900	S90SQASTO	Kit 4	198.12	237.75

Standard Tray

TOUCHSTONE

Square Tray *** WASTE NOT INCLUDED				
Tray Size	Code	Tray Panel Kit	Price £ Exc. VAT	Price £ Inc. VAT
760 x 760	S76SQTO	Kit 4	115.63	138.76
800 x 800	S80SQTO	Kit 4	129.57	155.48
900 x 900	S90SQTO	Kit 4	149.64	179.56

Square Tray Panel Kit – (Including Legs) *** WASTE NOT INCLUDED				
Tray Size	Code	Tray Panel Kit	Price £ Exc. VAT	Price £ Inc. VAT
1200 x 900	DRK4	Kit 4	131.96	158.35

Waste Complete Only			
	Code	Price £ Exc. VAT	Price £ Inc. VAT
	DWAS	39.06	46.87

THE TOUCHSTONE TRAY IS CAPPED WITH AN EASY TO CLEAN SURFACE THAT PROVIDES A CHEMICAL RESISTANT, ANTI-BACTERIAL SOLUTION DUE TO IT'S ULTRA-SMOOTH, NON-POROUS SURFACE.

Please Note: Price and order code does not include waste, waste must be ordered separately.

Design Details



Graduated adjustable leg and easy-fit tray panel kit.



90mm fast flow waste, includes hair trap and chrome cover.



Graduated adjustable leg system.



Square

90mm fast flow waste, includes hair trap and chrome cover.





Quadrant



Offset Quadrant



Left Handed (L) Right Handed (R)

Image above shown as Left Handed (L)
Please choose L for Left or R for Right when ordering.

Slip Resistant Tray TOUCHSTONE-SR

Quadrant Tray *** WASTE NOT INCLUDED				
Size	Code	Tray Panel Kit	Price £ Exc. VAT	Price £ Inc. VAT
800 x 800	S80QASTO	Kit 2	187.66	225.19
900 x 900	S90QASTO	Kit 2	209.84	251.81

Note: waste is centered on the 1700 x 800 and 1700 x 900 trays.

TOUCHSTONE-SR

Offset Quadrant Tray *** WASTE NOT INCLUDED				
Size	Code	Tray Panel Kit	Price £ Exc. VAT	Price £ Inc. VAT
1000 x 800 LH	S108QLASTO	Kit 1	284.78	341.74
1000 x 800 RH	S108QRASTO	Kit 1	284.78	341.74
1200 x 800 LH	S128QLASTO	Kit 1	299.80	359.76
1200 x 800 RH	S128QRASTO	Kit 1	299.80	359.76
1200 x 900 LH	S129QLASTO	Kit 1	353.75	424.50
1200 x 900 RH	S129QRASTO	Kit 1	353.75	424.50

This product is handed – please choose L for Left and R for Right when ordering.

Waste Complete Only			
Code	Price £ Exc. VAT	Price £ Inc. VAT	
DWAS	35.77	42.93	

Design Details



Graduated adjustable leg and easy-fit tray panel kit.



90mm fast flow waste, includes hair trap and chrome cover.



Graduated adjustable leg system.

90mm fast flow waste, includes hair trap and chrome cover.



Standard Tray TOUCHSTONE

Quadrant Tray *** WASTE NOT INCLUDED				
Tray Size	Code	Tray Panel Kit	Price £ Exc. VAT	Price £ Inc. VAT
800	S80QTO	Kit 2	141.76	170.12
900	S90QTO	Kit 2	158.45	190.14

Quadrant Tray Panel Kits (Including Legs) *** WASTE NOT INCLUDED				
Tray Size	Code	Tray Panel Kit	Price £ Exc. VAT	Price £ Inc. VAT
900	DRK2	Kit 2	131.96	158.35

TOUCHSTONE

Offset Quadrant Tray *** WASTE NOT INCLUDED				
Tray Size	Code	Tray Panel Kit	Price £ Exc. VAT	Price £ Inc. VAT
Right Hand				
1000 x 800	S108QRTO	Kit 1	215.08	258.10
1200 x 800	S128QRTO	Kit 1	226.42	271.70
1200 x 900	S129QRTO	Kit 1	267.16	320.59
Left Hand				
1000 x 800	S108QLTO	Kit 1	215.08	258.10
1200 x 800	S128QLTO	Kit 1	226.42	271.70
1200 x 900	S129QLTO	Kit 1	267.16	320.59

This product is handed.

Please choose (L) for Left or (R) for Right when ordering.

Offset Quadrant Tray Panel Kit (Including Legs) *** WASTE NOT INCLUDED				
Tray Size	Code	Tray Panel Kit	Price £ Exc. VAT	Price £ Inc. VAT
1200 x 900	DRK1	Kit 1	131.96	158.35

Please Note: Price and order code does not include waste, waste must be ordered separately.



Scan me for more information
on our slip resistant trays.
Level25-SR & Touchstone-SR



TOUCHSTONE-SR SLIP RESISTANT TRAY

MERLYN UPSTAND



Features

- ✓ Single skinned with 4 upstands
- ✓ Available with 90mm branded fast flow waste (optional extra)
- ✓ Available with tray panel kits (optional extra)
- ✓ 135mm high with tray panel set (148mm high including upstand)
- ✓ 50mm high (63mm with upstand)

Rectangular Tray Square Tray

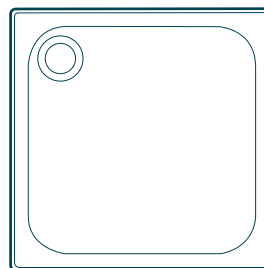

Rectangle Tray				
Tray Size	Code	Tray Panel Kit	Price £ Exc. VAT	Price £ Inc. VAT
900 x 760	S976RTUP	Kit 4	242.12	290.54
1000 x 800	S108RTUP	Kit 4	255.23	306.28
1200 x 760	S1276RTUP	Kit 4	277.65	333.18
1200 x 800	S128RTUP	Kit 4	294.34	353.21
1200 x 900	S129RTUP	Kit 4	315.86	379.03

Tray Panel Kit - Including Legs				
Tray Size	Code	Tray Panel Kit	Price £ Exc. VAT	Price £ Inc. VAT
1200 x 900	DRK4	Kit 4	131.96	158.35

Square Tray				
Tray Size	Code	Tray Panel Kit	Price £ Exc. VAT	Price £ Inc. VAT
760	S76SQUP	Kit 4	150.39	180.47
800	S80SQUP	Kit 4	168.39	202.06
900	S90SQUP	Kit 4	242.12	290.54

Waste Complete Only			
Code		Price £ Exc. VAT	Price £ Inc. VAT
DWAS		39.06	46.87

Please Note: Price and order code does not include waste, waste must be ordered separately.

90mm fast flow waste, includes hair trap and chrome cover.



Technical Section

We have produced this product section to help you with your purchasing decision. For further information please contact your local stockist, details of which can be found at www.merlynshowering.com

PRODUCT INFORMATION

All products are manufactured in accordance with EN 14428 and utilise toughened safety glass to EN 12150.

All doors feature adjustable wall profiles to compensate for out-of-true walls and have micro adjustment features for fine tuning to obtain a perfect fit and operating action.

All enclosures, wetrooms and panels are Power Shower approved – will retain water under normal showering conditions.

Water retention is maintained in all products under normal showering conditions.

A selection of Ionic enclosures are frameless in design. Spray/mist may escape therefore we would recommend use of these enclosures with tiled floors.

Opened cartons can not be returned. Returns carry a £40 box charge or £60 per unit where the sale is less than 30 days old. Returns over 30 days old will not be accepted.

All products are supplied complete with full installation instructions and the necessary fixings.

Check with your dealer for accurate matching of material samples.

Product descriptions do not imply the use of precious or valuable materials.

Our policy of reviewing product design and development on a regular basis means MERLYN reserve the right to change product specifications and prices without notice.

Only shower enclosures, panels and bath screens and some trays are covered by guarantees. Please contact the Ionic sales team for more details.

Glass shattering and parts subject to wear are not covered by your guarantee.

For full details on all product ranges please contact MERLYN Showering.

Trays shown in this catalogue are for illustrative purposes only.

Images are for illustrated purposes only. The colours and finishes shown in the catalogue are as accurate as possible within the limits of the printing process. The positioning of all showering heads in the brochure is for illustrative purposes only.

All descriptions, specifications and particulars contained in this brochure are intended merely to represent a general idea of the products described herein and none of these form part of any contract to give rise to any independent or collateral liability upon the company.

BATH SCREEN INFORMATION

Ionic Bath Screens are not designed to fit on baths with stepped fronts, roll top rims or integral soap dishes.

Fitting of screen on baths which have raised head rests or shapes is not recommended.

There must be no items causing obstruction with the seal and bath, as any of the above may cause leaks.

When choosing your Bath Screen, please ensure that if your bath has bath handles, that they do not interfere with the bath rim area where your screen will be placed.

When choosing an in-swing or folding Bath Screen, please ensure your swing area is not interfering with any brassware or internal shower features. Similarly, when choosing an out-swing, please ensure the out-swing area is free from any obstructions.

The Ionic MB7 Two Panel Hinged Bath Screen is handed so please ensure you state whether you require a right or left handed configuration when ordering.

Ionic Bath Screens are suitable for standard pressure showers and are not recommended for use with power showers.

It is recommended that the shower head position is situated on the same wall to which the Bath Screen is fixed and in the centre of the shower area.

CLEANING

- It is important to clean your Ionic shower door after every use.
- Wipe down all the glass and metal parts with a soft cloth.
- Do not allow lime scale to build up in hard water areas.
- Ensure that any residual water on the glass is removed after every use.
- Clean the glass regularly using soapy water.
- Do not use abrasive products on any surfaces.
- Install the enclosure in a well ventilated area.
- For more information on Mershield Stayclear™ glass please see page 6 of this brochure.

INFORMATION AND MAINTENANCE

Always read the instructions on the packaging, chrome is vulnerable to acid attack and some strong household cleaners including strong disinfectants, denture cleaners, hair dyes, wine making chemicals and photographic chemicals may contain acid. These materials may have a varying effect on the surface from black spots/streaks (which cannot be removed) to pitting the surface. Contact with these materials should be avoided.

IMPORTANT SHOWER TRAY INFORMATION

Although shower door and enclosure sizes are related to tray sizes it is important to note that most shower trays are tiled down to the rim, often over an “up-stand”. The finished installation space may be less than the nominal tray size.

Ionic shower units are made to suit this remaining space.

The guide below may be helpful in taking measurements to determine the shower door or enclosure size required. Dimensions given in this publication are in millimetres, are approximate and may vary with adjustment.

They are subject to change without notice.

Please note that when a tray is fitted it is essential that the tray is level before any doors or enclosures are fitted.

Tray upstands: ensure strong and secure joints between shower tray and walls, even in the event of floor settlement. Tiling must be finished over the recessed upstand as shown in the diagram below.

Cleaning: clean after every use with warm soapy water and wipe dry with soft cloth, never use a gritty or abrasive cleaner.

Take the measurements after the tray is installed and the walls are tiled.

Recess Location

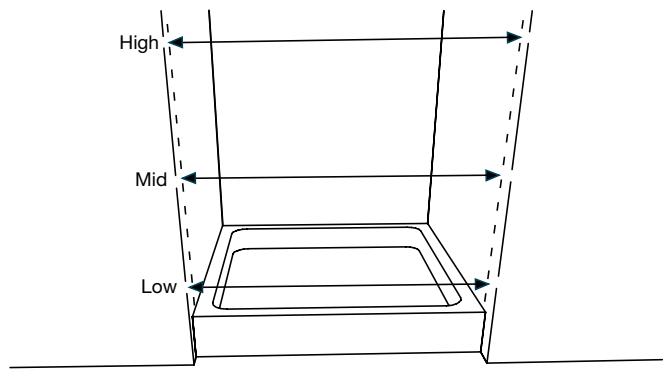

Corner Location

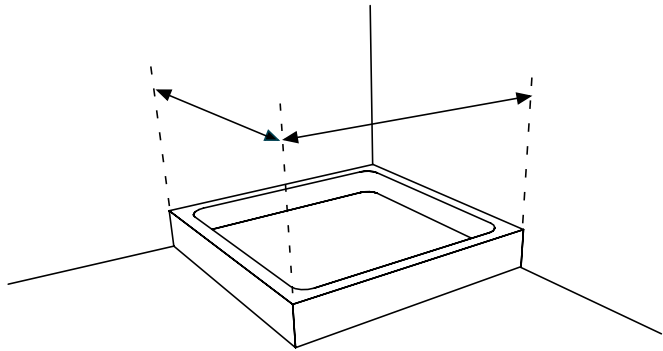

Wall Location

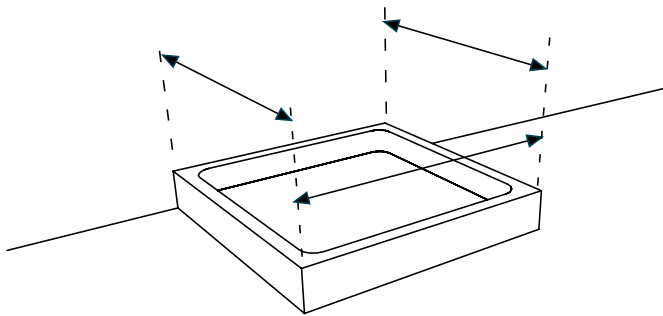

Quadrant Location

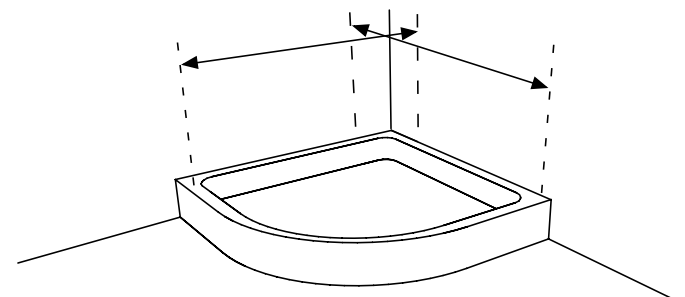

EXTENSION PROFILES

Essence Sliding & Quadrant Doors			
Size (H)	Code	Price £ Exc. VAT	Price £ Inc. VAT
2000mm	A0114E0	94.56	113.48

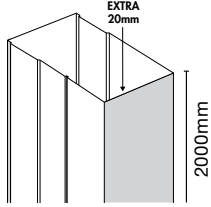

Essence Hinge & Inline Doors			
Size (H)	Code	Price £ Exc. VAT	Price £ Inc. VAT
2000mm	A0114D0	94.56	113.48

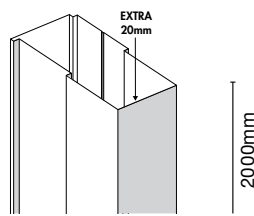

Essence Framed Extension Profile			
Size (H)	Code	Price £ Exc. VAT	Price £ Inc. VAT
1900mm	DWH14B0	94.56	113.48

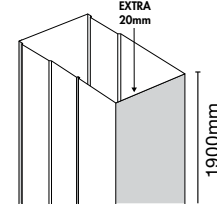

Express Extension Profile			
Size (H)	Code	Price £ Exc. VAT	Price £ Inc. VAT
1900mm	A0314B0	90.34	108.40

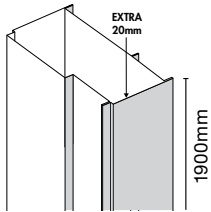

Source Extension Profile			
Size (H)	Code	Price £ Exc. VAT	Price £ Inc. VAT
1850mm	A1214C0	68.33	82.00

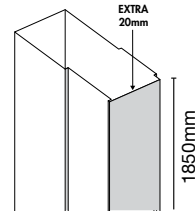

Waste positions for all Merlyn Upstands and TouchStone Trays

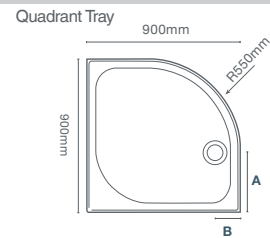
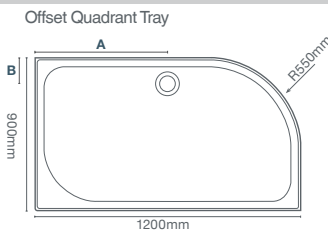
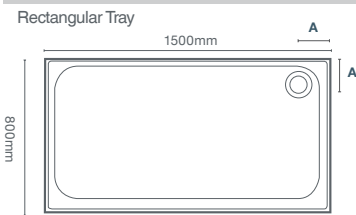

Rectangular Tray					
Size	TStone	Upstand	MStone	Waste Position (A)	Waste Position (B)
800 x 700	x			147	
800 x 760	x			147	
900 x 700	x			147	
900 x 760		x	x	147	
900 x 800	x			147	
1000 x 700	x			147	
1000 x 760	x			147	
1000 x 800	x	x	x	147	
1000 x 900	x			147	
1100 x 760			x	147	
1100 x 800	x		x	147	
1200 x 700	x		x	147	
1200 x 760	x	x	x	147	
1200 x 800	x	x	x	147	
1200 x 900	x	x	x	147	
1300 x 800	x			147	
1400 x 700	x			147	
1400 x 760	x			147	
1400 x 800	x		x	147	
1400 x 900	x		x	147	
1500 x 700	x		x	147	
1500 x 760	x			147	
1500 x 800	x		x	147	
1500 x 900	x		x	147	
1600 x 700	x			147	
1600 x 800	x		x	147	
1600 x 900	x		x	147	
1685 x 700	x		x	147	
1680 x 760	x		x	147	
*1700 x 800	x		x	130	850
*1700 x 900	x			130	850
*1800 x 800	x			130	900

Offset Quadrant Tray					
Size	TStone	Upstand	MStone	Waste Position (A)	Waste Position (B)
900 x 760 L			x	250	130
900 x 760 R			x	250	130
1000 x 800 L	x		x	350	130
1000 x 800 R	x		x	350	130
1200 x 800 L	x		x	450	130
1200 x 800 R	x		x	450	130
1200 x 900 L	x		x	450	130
1200 x 900 R	x		x	450	130
1400 x 800 L	x			510	300
1400 x 800 R	x			510	300

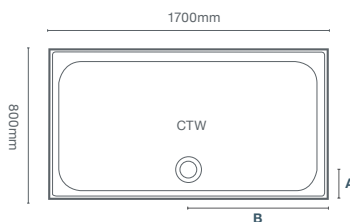
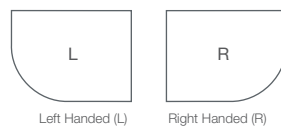

Waste is centred for 1700 x 800 (S178RTTO), 1700 x 900 (S179RTTO) and 1800 x 800 (S1888RTTO) trays

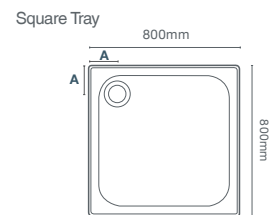

Square Tray					
Size	TStone	Upstand	MStone	Waste Position (A)	Waste Position (B)
760	x	x	x	147	147
800	x	x	x	147	147
900	x	x	x	147	147

Quadrant Tray					
Size	TStone	Upstand	MStone	Waste Position (A)	Waste Position (B)
800	x		x	250	130
900	x		x	350	130
1000			x	350	130

ADDITIONAL INFO IONIC EXPRESS INLINE PANELS

Ionic Express Pivot Door and Inline Panel					
Size	Code	Door Size mm	Inline Panel Size mm	Price Exc. VAT	Price Inc. VAT
650-690	A0306A0	700	-	549.43	659.32
670-710	A030001H	700	EXT.	639.77	767.72
710-750	A0306B0	760	-	549.43	659.32
750-790	A0306D0	800	-	549.43	659.32
780-840	A030002H	700	150	879.50	1055.40
840-900	A030003H	700	210	879.50	1055.40
850-890	A0306E0	900	-	632.36	758.84
900-960	A030004H	760	210	879.50	1055.40
950-990	A0306G0	1000	-	696.88	836.25
940-1000	A030005H	800	210	879.50	1055.40
980-1040	A030006H	900	150	962.40	1154.88
1040-1100	A030007H	900	210	962.40	1154.88
1080-1140	A030008H	1000	150	1026.92	1232.31
1140-1200	A030009H	1000	210	1026.92	1232.31

Ionic Express Bifold Door and Inline Panel					
Size	Code	Door Size mm	Inline Panel Size mm	Price Exc. VAT	Price Inc. VAT
710-750	A0300B0	760	-	615.90	739.08
750-790	A0300C0	800	-	615.90	739.08
850-890	A0300D0	900	-	658.18	789.81
900-960	A030010H	760	210	945.96	1135.15
950-990	A0300E0	1000	-	765.11	918.13
940-1000	A030011H	800	210	879.50	1055.40
980-1040	A030012H	900	150	988.20	1185.84
1040-1100	A030013H	900	210	988.20	1185.84
1080-1140	A030014H	1000	150	1026.92	1232.31
1140-1200	A030015H	1000	210	1095.17	1314.20

Ionic Express Sliding Door and Inline Panel					
Size	Code	Door Size mm	Inline Panel Size mm	Price Exc. VAT	Price Inc. VAT
950-990	A0304A0	1000	-	643.50	772.20
1050-1090	A0304B0	1100	-	643.50	772.20
1080-1140	A030016H	1000	150	973.54	1168.24
1140-1200	A030017H	1000	210	973.54	1168.24
1150-1190	A0304C0	1200	-	643.50	772.20
1180-1240	A030018H	1100	150	973.54	1168.24
1240-1300	A030019H	1100	210	973.54	1168.24
1280-1340	A030020H	1200	150	973.54	1168.24
1340-1400	A030021H	1200	210	973.54	1168.24
1350-1390	A0304DH	1400	-	827.87	993.44
1370-1450	A030022H	1100	150+ 210	1303.58	1564.30
1450-1490	A0304GH	1500	-	881.27	1057.52
1480-1540	A030023H	1400	150	1157.92	1389.50
1540-1600	A030024H	1400	210	1157.92	1389.50
1580-1640	A030025H	1500	150	1211.33	1453.59
1640-1700	A030026H	1500	210	1211.33	1453.59
1650-1690	A0304HH	1700	-	912.72	1095.26
1670-1750	A030027H	1400	150 + 210	1487.98	1785.57
1730-1810	A030028H	1400	210 x 2	1487.98	1785.57
1780-1840	A030029H	1700	150	1242.78	1491.34
1840-1900	A030030H	1700	210	1242.78	1491.34

PLEASE NOTE

Prices were correct at time of print, April 2023. V.A.T. at the rate of 20%. E&OE. Due to circumstances beyond our control, prices may be altered including changes to the rate of V.A.T.

Due to our policy of continuous improvement, we reserve the right to amend prices, specifications and designs without prior notice.

Images are for illustrated purposes only. The colours and finishes shown in the catalogue are as accurate as possible within the limits of the printing process. All descriptions, specifications and particulars contained in this brochure are intended merely to represent a general idea of the products described herein and none of these form part of any contract to give rise to any independent or collateral liability upon the company.

MERLYN™

Unit 8, Purcellsinch Industrial Estate, Dublin Road, Kilkenny, Ireland, R95 HP71.

T 0808 1011 429 / F 0808 1011 428

E sales@merlyn.ie / technical@merlyn.ie

www.merlynshowering.com



MERLYN™ IONIC

